

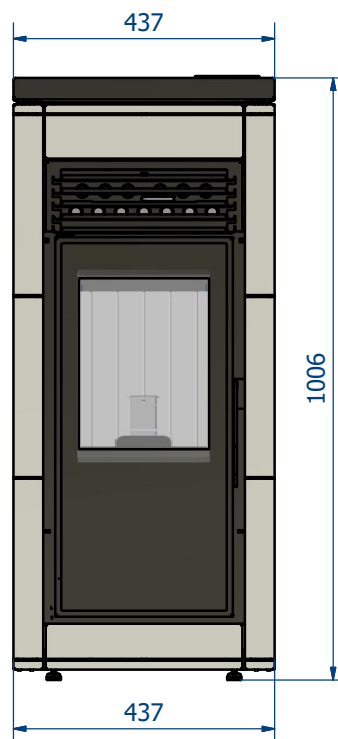

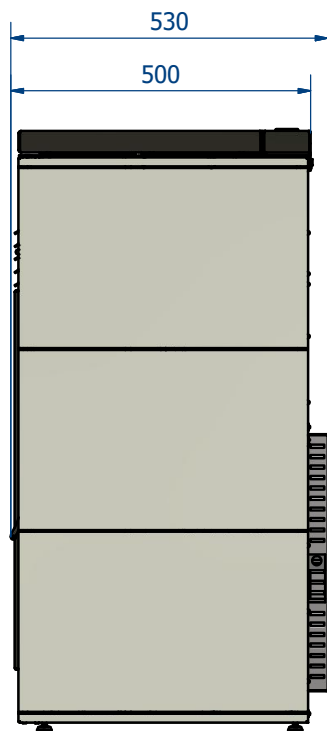



CHIMENEAS Y BARBACOAS FERLUX, S.A.
 POLIG. INDUST. EL POLEAR, PARC. 1
 29313 VILLANUEVA DEL TRABUCO MALAGA (ESPAÑA)
 TEL. +34 952 03 11 17 FAX +34 952 03 11 18



- | | |
|---|---|
| Rojo Imperial | Marrón Vintage |
|  |  |
| Blanco Perla | Negro |
|  |  |

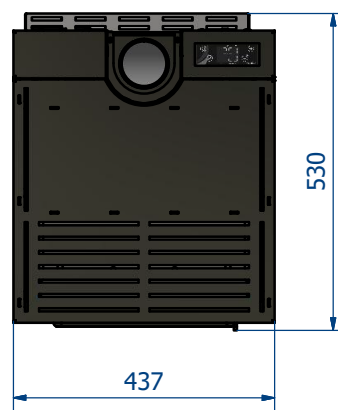



CHIMENEAS Y BARBACOAS FERLUX, S.A.
 POLIG. INDUST. EL POLEAR, PARC. 1
 29313 VILLANUEVA DEL TRABUCO MALAGA (ESPAÑA)
 TEL. +34 952 03 11 17 FAX +34 952 03 11 18

Accesorio opcional:

Salida de gases vertical

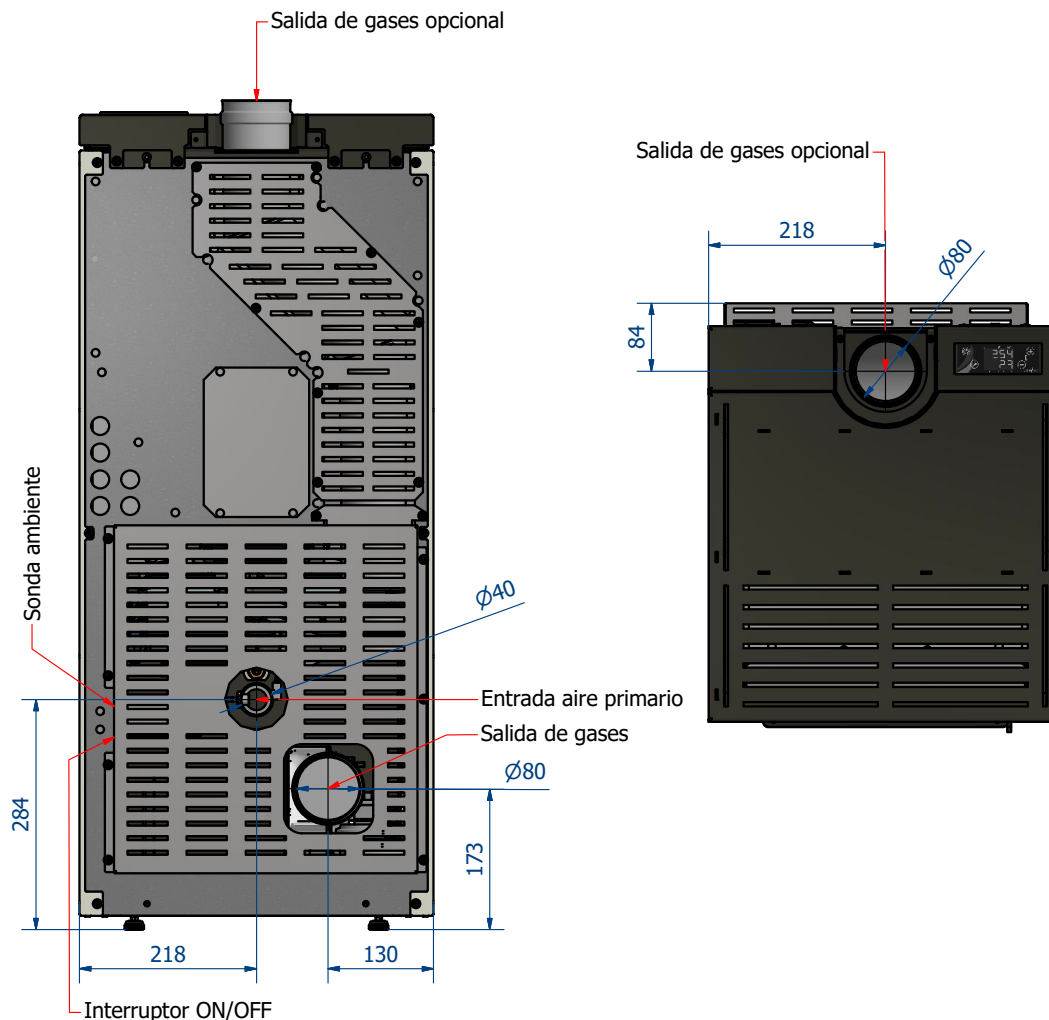
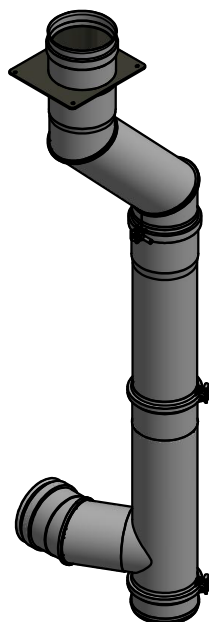

Datos técnicos

POTENCIA TÉRMICA NOMINAL	6,1 KW
POTENCIA TÉRMICA AMBIENTAL	6,1 KW
POTENCIA TÉRMICA REDUCIDA	2,8 KW
RENDIMIENTO P.T.N.*	90%
RENDIMIENTO P.T.R.**	94%
CONSUMO (MIN-MAX)	0,6 KG - 1,4 KG
AUTONOMÍA (MIN-MAX)	35 - 15 HORAS
EMISIONES CO AL 13% DE O ₂ (P.T.N. - P.T.R.)	0,01% - 0,04%
PARTICULADO - OGC - NOX (13% O ₂ mg/Nm ³)	16 - 30 - 99
TEMPERATURA DE HUMOS (P.T.N. - P.T.R.)	101 °C - 62 °C
VOLUMEN CALEFACTABLE	150 M ³
SALIDA DE HUMOS	80 MM
ENTRADA DE AIRE PRIMARIO	40 MM
PESO	103 KG
CAPACIDAD DEL DEPÓSITO	21 KG

Requisitos eléctricos

ALIMENTACIÓN	220 - 230 V
FRECUENCIA	50 - 60 Hz
POTENCIA EN EL ENCENDIDO	367 W
POTENCIA MEDIA ABSORBIDA	67 W

DETALLE DE TAPA DESLIZANTE



CHIMENEAS Y BARBACOAS FERLUX, S.A.
POLIG. INDUST. EL POLEAR, PARC. 1
29313 VILLANUEVA DEL TRABUCO MALAGA (ESPAÑA)
TEL. +34 952 03 11 17 FAX +34 952 03 11 18

